

Established 1885

**Randall Brothers**

INCORPORATED

**9800 Series**

**SPECIAL ORDER  
MOULDING CATALOG**



Established 1885  
**Randall Brothers**  
INCORPORATED

**9800 SERIES**  
**SPECIAL ORDER**  
**MOULDING CATALOG**  
**DECEMBER 1999 EDITION**

Welcome to Randall Brothers Revised 1999 Edition special order moulding catalog. In it you will find profiles that reflect classical architecture with timeless appeal and enduring value. The 90's have shown a tremendous revival in architectural millwork detail, which has demanded the need for a moulding book that would show profiles appropriate to be used in a variety of applications such as: grand estate homes, historic restoration, finer home construction, and decorative renovation. The patterns were developed to meet the discriminating tastes of Atlanta's renowned architects, interior designers, master builders and quality minded remodelers. Architectural profile details come from a variety of influences inspired by the current renaissance in classicism. Many patterns were designed specifically for the estate homes in the Buckhead residential area and represent a cooperative effort with some of Atlanta's finest architects. The Buckhead Street names were used to reflect the rich heritage of Classical architecture in the area. Though respecting the architectural traditions of the past, there are also some innovative new patterns that use the best of late twentieth century millwork technology to create the appearance of elaborate ornamentation while reducing the cost of manufacturing and make installation simpler for today's high-tech craftsman. Look through the catalog and you will see designs that can be used in a multitude of applications. This truly masterful collection includes period mouldings for Georgian entrances and architraves, authentic Williamsburg casings and chair rails, Victorian casings, Greek Revival pilaster details and Renaissance interior cornices. Two of the unique features of the catalog are the assembly details for built-up cornices and multi-piece crowns and the cross-section views for raised paneled rooms and wainscoting. Also notice that many of the mouldings have more than one application. As an example, the Rembrandt series can be used as a casing with back band or as a crown apron or as a two-pieced chair rail or as a baseboard. Panel moulds can be applied as base caps or conversely base caps may be used as a panel moulds. Some casings can be applied as chair rails, mantle moulds, crown aprons or even one-piece baseboards. Used in conjunction with Randall Brother's standard RB stock patterns, the design possibilities are endless. Randall Brothers has been in the millwork business longer than anyone in the metropolitan area, and has a treasury of moulding profiles available for your custom millwork needs. If you can't find a pattern suitable for a unique application, let us know, our knife grinding charges are very reasonable, and we would be glad to produce your custom moulding designed to your specifications. Mouldings are typically produced in solid or finger-joint poplar for paint grade applications. Stain grade hardwoods are available such as oak, mahogany, cherry, maple, birch, ash, walnut and other exotic species. Softwoods are available including white pine, southern yellow pine, clear cedar and clearheart redwood. Exteriors are recommended in cedar, redwood or yellow pine. Custom shop drawings are available for some appropriate large projects, after order placement, to verify details. Typical lead times for the 9800 series and 9900 series special order patterns vary from two to four weeks. See attached stock list for patterns ready to ship. Please call us to verify current pricing and availability.

**Randall Brothers Inc.**  
**665 Marietta Street N.W.**  
**Atlanta, Ga. 30313**

**Phone: 404/892-6666**  
**Watts: 800/476-4539**  
**Fax: 404/875-6102**

**RANDALL BROTHERS 9800 SERIES  
SPECIAL ORDER MOULDING  
TABLE OF CONTENTS**



Moulding No.	Name	Description	Size (in inches)		Notes	Page
RB-9800	Renaissance	Crown	¾	5-½	1" to 1-1/16" Rabbet	55,84
RB-9801	Tuxedo Road	Backband	1-5/8	2-1/8	1-1/2" Rabbet	7,8
RB-9801-1-1/2	Tuxedo Court	Backband	1-5/8	2-1/2	5/8" to ¾" Rabbet	9
RB-9802	Rilman	Backband	1-5/16	1-3/8	5/8" to ¾" Rabbet	16,19
RB-9803	Monroe	Backband	1-5/16	1-3/8	11/16" to ¾" Rabbet	15,16,18
RB-9804-3/4	Madison	Backband	1-5/8	1-3/4	1" to 1-1/16" Rabbet	14,19
RB-9804-1	Madison	Backband	1-3/4	1-13/16	5/8" to ¾" Rabbet	20
RB-9805-3/4	Ranier	Backband/Chairrail	1-5/8	1-5/8	5/8" to ¾" Rabbet	13,14
RB-9805-1	Ranier	Backband/Chairrail	1-5/8	2-1/16	1" to 1-1/16" Rabbet	8,18,41
RB-9806	Paran	Panel Mould	¾	1-1/16	½" Rabbet	35,40
RB-9807	Ridgewood	Panel Mould	¾	2-1/16	½" Rabbet	35,42
RB-9808	Ridgemore	Panel Mould	1-1/16	2-1/4	¾" Rabbet	33,35
RB-9809	Whitmore	Panel Mould/Basecap	1-1/16	2-1/8	¾" Rabbet	35,41
RB-9810	Wellesley	Panel Mould	¾	1-3/4	½" Rabbet	35
RB-9811	Tuxedo Road	Casing	1-1/16	4-3/8	(Use 9814 Series Mulls)	7,11
RB-9812	Tuxedo Park	Casing	1-1/16	5-1/2	(Use 9814 Series Mulls)	7
RB-9813	Tuxedo Court	Exterior Casing	1-1/2	5-1/2		9
RB-9814	Tuxedo	Mulls	5/8	Varies	**See page 5**	24
RB-9815	Powers	Cove	1	1		45
RB-9816	Lafayette	Crown	1-1/2	5-1/4		56
RB-9817	Benton	Crown (6")	¾	5-1/2		55,76
RB-9818	Stovall	Cove (8")	1-1/4	7-1/4		59
RB-9819	Stratford	Cove (10")	1-1/2	9-1/4		60
RB-9820	Williamsburg	Brickmould	1-3/16	3-1/4		27
RB-9821	Habersham Park	Casing	1-1/2	4-1/2	Use 8800 Series Mulls	11
RB-9822	Habersham Road	Casing	1-1/4	4-1/2	Use 8800 Series Mulls	11
RB-9823-2	Old Ivy	Casing/Apron/Chairrail	¾	2-5/8	Use 8800 Series Mulls	13
RB-9823-3	Old Ivy	Casing/Apron	¾	3-1/2	Use 8800 Series Mulls	13
RB-9823-4	Old Ivy	Casing/Apron	¾	4-1/2	Use 8800 Series Mulls	13,15
RB-9824	Lenox	Casing	1-1/16	4-1/2		20
RB-9824-4	Lenox	Plinth	1-3/16	4-3/4		20
RB-9824-5	Lenox	Plinth	2-1/16	5-13/16		20
RB-9825	Fairfield	Casing	1-1/16	3-1/2		10
RB-9826	Dover Road	Casing/Chairrail	1-1/16	2-1/2		10
RB-9827	Paces Valley	Casing/Mantle Mould	1-5/16	4-1/2	Use 9927 Series Mulls	22
RB-9828	Wood Valley	Casing/Mantle Mould	1-1/4	3-1/2	Use 9928 Series Mulls	22
RB-9829	Hyde	Raised Panel Mould	¾	2-7/16	For ¾" Plywood	36
RB-9830	Vernon	Raised Panel Mould	5/8	2-1/4	For ¾" MDF	36,41,42
RB-9831	Tuxedo Road	Plinth	2-1/4	5-3/4		7,8
RB-9832	Tuxedo Park	Plinth	2-1/4	6-7/8		7,8
RB-9833	Tuxedo Court	Plinth	2-3/4	6-7/8		9
RB-9834	Habersham Park	Plinth	1-5/8	4-3/4		11
RB-9835	Habersham Road	Plinth	1-3/8	4-3/4		11,17
RB-9836-2	Wilson	Plinth	1-3/4	3-15/16		13
RB-9836-3	Wilson	Plinth	1-3/4	4-3/4		13,14
RB-9836-4	Wilson	Plinth	1-3/4	5-3/4		13,14
RB-9837-2	Rembrandt	Casing/Apron/Chairrail	¾	2-5/8	Use 9957 Series Mulls	14,54,84

# RANDALL BROTHERS 9800 SERIES SPECIAL ORDER MOULDING TABLE OF CONTENTS

Moulding No.	Name	Description	Size (in inches)		Notes	Page
RB-9837-3	Rembrandt	Casing/Apron/Base	¾	3-1/2	Use 9957 Series Mulls	14,15,82
RB-9837-4	Rembrandt	Casing/Apron/Base	¾	4-1/2	Use 9957 Series Mulls	14
RB-9838	Fairfield	Plinth	1-3/26	3-3/4		10
RB-9839	Trafalgar	Capital/Mould/Crown	1-3/8	2		45,76,77
RB-9840	Wellington	Brickmould/Large Base	1-7/8	3		27
RB-9841	Regency	Basecap/Capital Mould	1-5/8	2-1/2		34,27
RB-9842	Heritage	Basecap/Panel Mould	15/16	1-3/4		31
RB-9843	Foxcroft	Baseboard/Apron	¾	5-1/2		31,39
RB-9844	Barrington	Casing/Chairrail	1-1/16	5-1/2		8
RB-9845	Westminster	Plinth	1-1/4	4-5/8		10
RB-9845-4	Westminster	Casing	1-3/8	4-7/8		10
RB-9846	Victoria	Dentil Crown	¾	5-1/2	(Use 1-1/16"x5-3/4" Rosette)	21
RB-9847	East Wesley	Chairrail	1-1/4	3-5/8		68,67,66
RB-9848-2	Carlton	Chairrail	1-1/4	2-5/8		29
RB-9848-3	Carlton	Panel Mould	1-1/2	3-1/2		29
RB-9849	Chateau	Basecap/Panel Mould	¾	1-5/8	½" Rabbet	37
RB-9850	Chateau	Chairrail	¾	1-3/4		31,40
RB-9851	Castlegate	Beaded Becker	1-3/4	4-3/8		28
RB-9852	Castlegate	Chairrail	½	7-1/4		28
RB-9853	Wyngate	Chairrail	1-1/8	3-3/16		28
RB-9854	Kingswood	Chairrail	1-1/16	2-1/2		30
RB-9855	Queensbury	Chairrail	1-1/4	2-7/8		30,42
RB-9856	Imperial	Chairrail/Casing	1-3/8	3-1/2		29
RB-9857	Alexander	Trim(for dentil block)	5/8	¾		64,63,62
RB-9857-2	Buckingham	Dentil Plate	¾	2-1/2	(Rabbeted for 9857)	62
RB-9857-3	Hamilton	Dentil Plate	¾	3-3/8	(Rabbeted for 9857)	64,63
RB-9858	Haddon	Panel Mould/Basecap	5/8	5/8		45
RB-9859	Radcliffe	Panel Mould/Basecap	¾	7/8		37
RB-9860	Chatsworth	Ogee Crown (5")	¾	4-5/8		52
RB-9861	Amherst	Crown (3")	½	2-13/16		48,74,75
RB-9862	Asheworth	Crown (4")	5/8	3-1/2		48,63
RB-9863	Arden	Crown (5")	¾	4-5/8		48,65,62
RB-9864	Andover	Crown (6")	¾	5-1/2		48
RB-9865	Andrews	Crown (7")	7/8	6-1/16		49
RB-9866	Argonne	Crown (8")	1	7-1/4		51
RB-9867	West Wesley	Dentil Crown (6")	1-5/8	5-9/16		52,65,63
RB-9868	West Wesley	Dentil Insert (uncut)	¾	1-1/8		52
RB-9868-3/8	West Wesley	Dentil Insert w 3/8" notch	¾	1-1/8		64,63,69
RB-9869-2	Hamilton	Dentil Block 2" wide	1-7/8	3-3/8		64,63
RB-9870-2	Budkingham	Dentil Block 2" wide	1-3/4	2-1/2		62
RB-9871	West Paces	Cove (8")	1-1/2	7-3/16		61,73,79
RB-9872	East Paces	Cove (6")	1-1/4	5-1/2		61,74,80
RB-9873	Paces	Picture Mould Basecap	1	1-3/4		45,73,74
RB-9874	Conway	Cove (4")	¾	3-1/2		51,78
RB-9875	Chastain	Cove	1-1/16	5-1/2		51,77,83
RB-9876	Chatham	Crown	1-1/2	3-1/2		56,78
RB-9877	Grant	Cove (4")	11/16	3-1/2		57
RB-9878	Gatewood	Cove (5")	¾	4-5/8		57
RB-9879	Garraux	Cove (6")	1-1/16	5-1/2		57
RB-9880	Garmon	Cove (8")	1-1/16	7-1/4		58
RB-9881-3/4	Hanover	Shelf Edge	5/8	¾		45
Rb-9881-1-1/4	Hanover	Shelf Edge	¾	1-1/4		45

# RANDALL BROTHERS 9800 SERIES SPECIAL ORDER MOULDING TABLE OF CONTENTS

Moulding No.	Name	Description	Size (in inches)			
RB-9882-3	Glenridge	Beaded Flat Casing	3/4	3-1/2		19
RB-9882-5	Glenridge	Beaded Flat Casing	3/4	5-1/2		19
RB-9883	Sheridan	Cove (6")	1-1/16	5-1/2		59,67
RB-9884	Harris	Basecap	7/8	1-3/4		33
RB-9885	Windsor	Panel Mould/Basecap	3/4	2-5/8	3/4" Rabbet	33,36
RB-9886	Baker	Raised Panel Mould	3/4	2-7/16	For 3/4" Plywood	36,39,40
RB-9887	Paces Valley	Plinth	1-1/2	4-3/4		22
RB-9888	Wood Valley	Plinth	1-3/8	3-3/4		22
RB-9889	Normandy	Breast Mould	3/4	3-1/2		45,62
RB-9890	Mitchell	Pencil Mould	11/16	11/16	For 3/4" Stock	45
RB-9891-2-1/2	Woodhaven	Stool	1-1/16	2-1/2	Non-rabbeted	43
RB-9891-3-1/8	Woodhaven	Stool	1-1/16	3-1/8	Non-rabbeted	43
RB-9891-5	Woodhaven	Stool	1-1/16	5	Non-rabbeted	43
RB-9892-2-5/8	Rodenhaven	Stool	1-1/16	2-5/8	Rabbeted	44
RB-9892-3-5/8	Rodenhaven	Stool	1-1/16	3-5/8	Rabbeted	44
RB-9892-5-1/2	Rodenhaven	Stool	1-1/16	5-1/2	Rabbeted	44
RB-9893	Wickersham	Casing/Apron	1-1/16	2-1/2		45
RB-9894	Baker	Casing/Apron/Baseboard	1-1/16	4-3/8		8
RB-9895	Woodward	Picture Mould	13/16	1-7/8		47
RB-9896	Westover	Picture Mould	1-1/16	2-1/2		47
RB-9897	Tuscan	Capital Mould/Chairrail	1-3/4	2-3/8		46,39,40
RB-9898	Tuscan	Neck Mould	5/8	1		46
RB-9899	Tuscan	Base Mould	1-5/8	2-3/8		46
RB-9901	Pincrest	1x4 with Backband (1pc)	1-1/4	4-1/2		27
RB-9902	Townsend	Backband/Chairrail	1-1/16	1-5/16	11/16" to 3/4" Rabbet	15,16,30
RB-9903	Davidson	Backband	1-5/8	1-3/4	1" to 1-1/16" Rabbet	12,11,18
RB-9904	Brookhaven	Casing	1-1/16	4-1/2	Use 8800 Series Molds	12
RB-9905	East Baker	Crown	1-5/16	4-5/8	*Speed Cornice*	68,71
RB-9906	West Baker	Crown	1-5/8	5-5/8	*Speed Cornice*	69,72
RB-9907	Wesley Ridge	Dentil Crown	1-5/16	4-5/8	*Speed Cornice*	69
RB-9908	Cherokee Road	Crown (8")	1-1/16	7-1/4	*Speed Cornice*	50
RB-9909	Rivers	Panel Mould	3/4	2-1/8		35
RB-9910	Cochran	Casing/Chairrail	3/4	2-5/8		16
RB-9911	Valley	Casing/Chairrail	3/4	2-5/8		18,30
RB-9912	Crest Valley	Casing/Chairrail	1-1/16	3-1/2		18
RB-9913	Beechwood	Casing	3/4	3-1/2		16
RB-9914	Brentwood	Casing	3/4	4-1/2		16
RB-9915	London	Crown (4")	5/8	3-1/2		53
RB-9916	New London	Crown (5")	11/16	4-1/2		53
RB-9917	Londonberry	Crown (6")	11/16	5-1/2		53,82
RB-9918	Georgian	Chairrail	1-5/8	1-7/8		30
RB-9919	Georgian	Capital Mould/Chairrail	1-3/16	2-1/8		30
RB-9920	Devonshire	Casing/Chairrail	1-1/16	3-1/2		18
RB-9921	Wendover	Casing	1-5/16	4-1/2		21
RB-9922	Whittington	Casing	1-1/4	5-1/2		21
RB-9923	Piedmont	Base Cap	3/4	1-3/4		32
RB-9924	Pharr	Baseboard	3/4	5-1/2		32
RB-9925	Phipps	Baseboard	3/4	7-1/4		32
RB-9926-3	Wieuca	Plinth	1-1/2	4-13/16		15,16
RB-9926-4	Wieuca	Plinth	1-1/2	5-13/16		15,16



**RANDALL BROTHERS 9800 SERIES  
SPECIAL ORDER MOULDING  
TABLE OF CONTENTS**



**\*\*\*MULLS\*\*\***

<b>Moulding No.</b>	<b>Name</b>	<b>Description</b>	<b>Size (in inches)</b>	<b>Notes</b>	<b>Page</b>
RB-9814-1-1/2	Tuxedo	Mull 1-1/2"	5/8		24
RB-9814-1-3/4	Tuxedo	Mull 1-3/4"	5/8		24
RB-9814-2	Tuxedo	Mull 2"	5/8		24
RB-9814-3	Tuxedo	Mull 3"	5/8		24
RB-9814-3-1/2	Tuxedo	Mull 3-1/2"	5/8		24
RB-9814-5-3/8	Tuxedo	Mull 5-3/8"	5/8		24
RB-9814-5-5/8	Tuxedo	Mull 5-3/8"	5/8		24
RB-9814-7-1/4	Tuxedo	Mull 7-1/4"	5/8		24
RB-9927-1-1/2	Paces Valley	Mull 1-1/2"	13/16		23
RB-9927-2	Paces Valley	Mull 2"	13/16		23
RB-9927-3	Paces Valley	Mull 3"	13/16		23
RB-9927-3-1/2	Paces Valley	Mull 3-1/2"	13/16		23
RB-9927-7-1/4	Paces Valley	Mull 7-1/4"	13/16		23
RB-9928-1-1/2	Wood Valley	Mull 1-1/2"	5/8		23
RB-9928-2	Wood Valley	Mull 2"	5/8		23
RB-9928-3	Wood Valley	Mull 3"	5/8		23
RB-9928-3-1/2	Wood Valley	Mull 3-1/2"	5/8		23
RB-9956-1-1/2	Harris	Mull 1-1/2"	9/16		26
RB-9956-2	Harris	Mull 2"	9/16		26
RB-9956-3	Harris	Mull 3"	9/16		26
RB-9956-3-1/2	Harris	Mull 3-1/2"	9/16		26
RB-9957-2	Rembrandt	Mull 2"	1/2		25
RB-9957-3	Rembrandt	Mull 3"	1/2		25
RB-9957-3-1/2	Rembrandt	Mull 3-1/2"	1/2		25
RB-9958-3	Baker	Mull 3"	5/8		25
RB-9958-3-1/2	Baker	Mull 3-1/2"	5/8		25
RB-9960	Ivy	Bead	15/32	Use with 1/2" D4S	26

**RANDALL BROTHERS 9800 SERIES  
SPECIAL ORDER MOULDING  
TABLE OF CONTENTS**



**\*\*CORNICES\*\***

Moulding No.	Name	Description	Size (in inches)		Notes	Page
RB-99870	Buckingham	Cornice (10 pc.)	15-13/16"	10-1/2"	* See Detail*	62
RB-99869	Hamilton	Cornice (9 pc.)	10-15/16"	11-7/8"	* See Detail*	63
RB-59867	West Wesley	Cornice (5 pc.)	9-3/8"	8-5/16"	9867 + 9868 - 9863 + Askins	65
RB-39847	East Wesley	3-Piece Speed Crown	7"	5-1/16"	9847 + 707 - 17	66
RB-59871	West Paces	Cornice (5 pc.)	11-1/4"	8-5/8"	9871 - 9873 - 9863 + Askins	73
RB-59872	East Paces	Cornice (5 pc.)	8-9/16"	6-1/4"	9872 + 9873 - 9861 Askins	74
RB-49876	Chatham	Cornice (4 pc.)	6-1/2"	8-13/16"	9876 + 9874 + Askins: 4-1/2+5-1/2	78
RB-49875	Chastain	Cornice (4 pc.)	7-11/16"	9-1/8"	9875 + 9839 - Askins: 4" + 7-1/4	77
RB-39864	Andover	3-Piece Crown	7-15/16"	6-13/16"	9864 + 9837 - 3 + 9837 - 3	81
RB-39865	Andrews	3-Piece Crown	7-1/16"	5-11/16"	9865 - 9934 - 9934	47
RB-49861	Amherst	Cornice (4 pc.)	6-1/4"	9-7/16"	9861 - 9001 - Askins: 4" + 7-1/4	75
RB-49817	Benton	Cornice (4 pc.)	7"	5-1/16"	9817 - 9839 - Askins: 4" + 5-1/2	76
RB-39883	Sheridan	Cornice (3 pc.)	6-13/16"	5-1/4"	9883 - 9847 + 707	67
RB-39871	West Paces	3-Piece Cove	7"	6-3/4"	9871 + 9873 - 9873	79
RB-39872	East Paces	3-Piece Cove	5-11/16"	5-5/8"	9872 - 9873 - 9873	80
RB-29800	Renaissance	2-Piece Crown	6-5/16"	4-1/4"	9800 + 9837 - 2	84
RB-39905	East Baker	3-Piece Speed Cornice	6-1/16"	4-3/4"	9905 + 9847 + 707	68
RB-39906	West Baker	3-Piece Speed Cornice	7-3/8"	6-1/2"	9906 - 9907 + 9868-3/8	69
RB-29935	Virginia	2-Piece Speed Cornice	6"	4-3/4"	9935 - 9905	71
RB-29938	N. Virginia	2-Piece Speed Cornice	7-3/8"	6-1/2"	9938 - 9906	72
RB-39943	Old London	3-Piece Crown	8-13/16"	7-7/16"	9943 - 9837 - 3 - 9837 - 2	54
RB-39917	Londonberry	3-Piece Crown	8-1/16"	6-5/8"	9917 + 9837 - 3 + 9837 - 3	82
RB-29875	Chastain	2-Piece Crown	6-3/4"	4-1/2"	9875 + 9837 - 3	83
RB-9944	Baker	Crown (Speed Cornice)	4-3/16"	4-3/8"	9944	70
RB-9961	Paces Forest	Cove (Speed Cornice)	5-7/16"	4-13/16"	9961	85

# RANDALL BROTHERS, INC.

665 MARIETTA STREET N.W.; ATLANTA, GA.

1-404  
PHONE 892-6666

1-404  
FAX. 875-6102

7

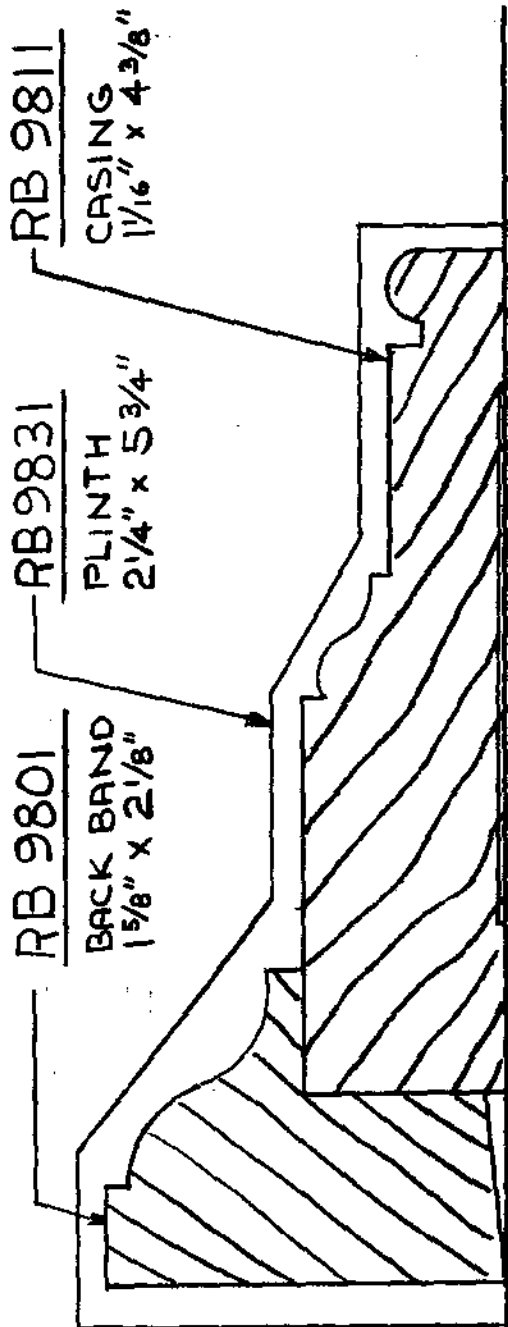

TUXEDO ROAD CASING

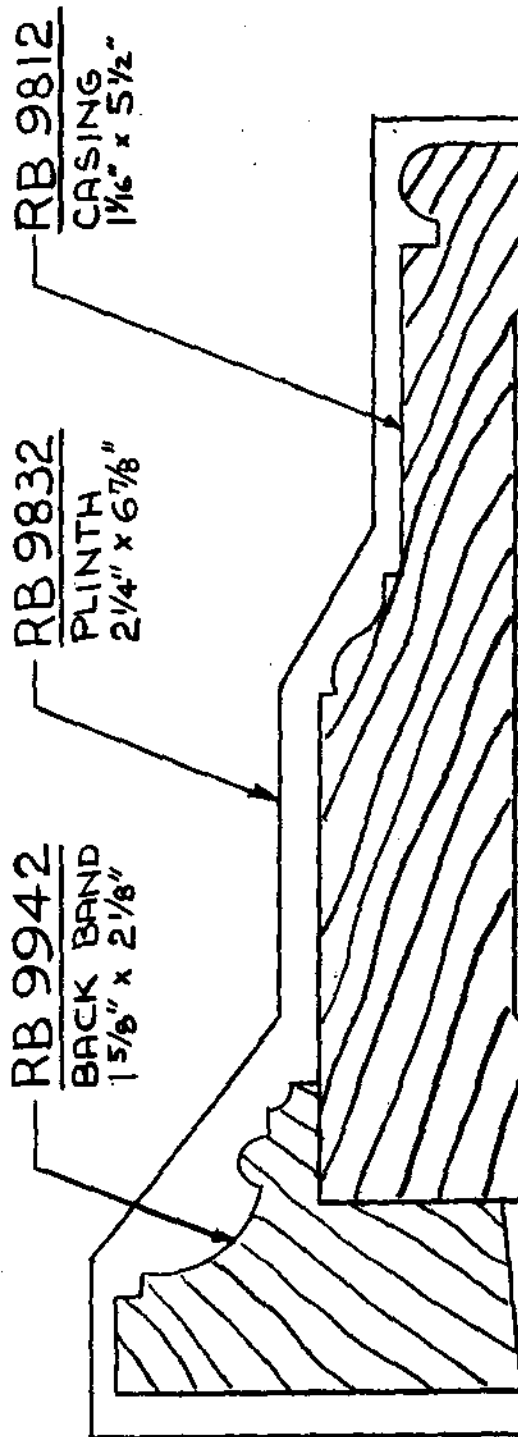

TUXEDO PARK CASING

# RANDALL BROTHERS, INC.

665 MARIETTA STREET N.W., ATLANTA, GA.

1-404  
PHONE 892-6666

1-404  
FAX. 875-6102

8

RB 9894  
CASING  
1 1/16" x 4 3/8"

RB9831  
PLINTH  
2 1/4" x 5 3/4"

RB 9801-1  
BACK BAND  
1 7/8" x 2 1/8"

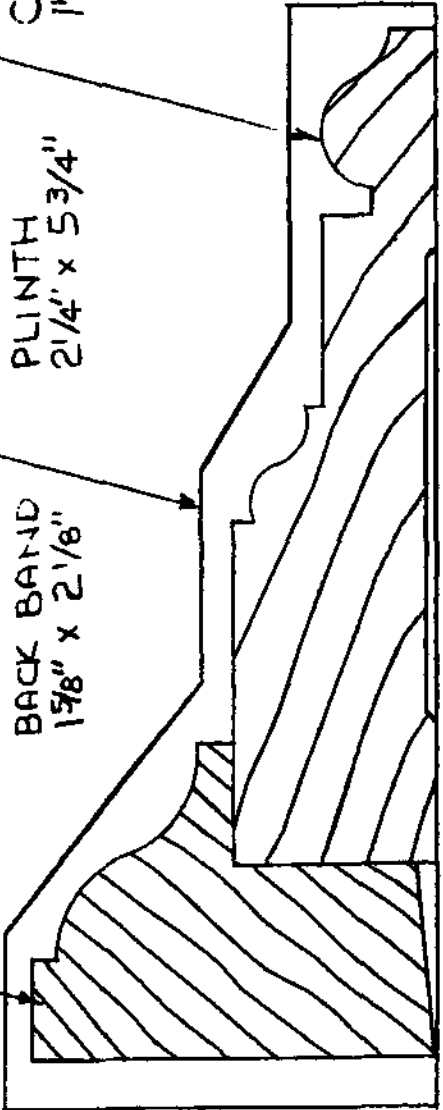

## BAKER CASING

RB 9844  
CASING  
1 1/16" x 5 1/2"

RB9832  
PLINTH  
2 1/4" x 6 7/8"

RB 9805-1  
BACKBAND  
1 5/8" x 2 1/16"

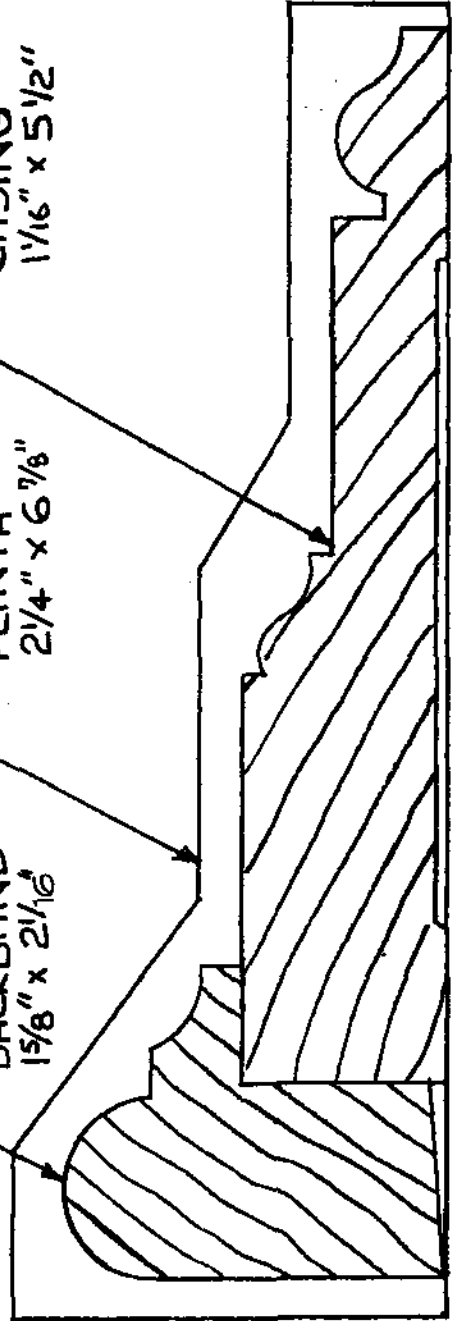

## BARRINGTON CASING

# RANDALL BROTHERS, INC.

865 MARIETTA STREET N.W., ATLANTA, GA.

1-404  
PHONE 892-8666

1-404  
FAX 875-6102

9

## TUXEDO COURT BRICK MOULD

<u>RB 9801-1 1/2</u>	<u>RB 9813</u>	<u>RB 9833</u>
TUXEDO COURT	TUXEDO COURT	TUXEDO COURT
BACK BAND	CASING	PLINTH
1 5/8" x 2 1/2"	1 1/2" x 5 1/2"	2 3/4" x 6 7/8"

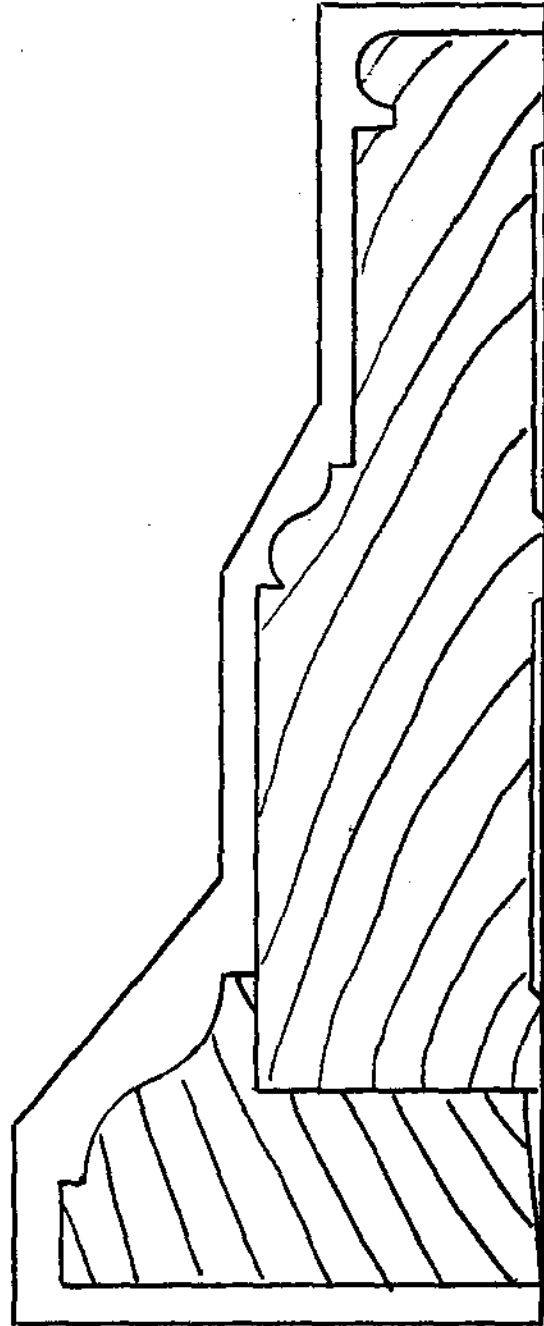

# RANDALL BROTHERS, INC.

665 MARIETTA STREET N.W.; ATLANTA, GA.

1-404  
PHONE 892-6666

1-404  
FAX 875-6102

10

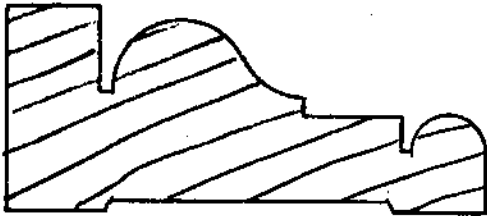

RB 9826

DOVER ROAD  
CASING  
1 1/16" x 2 1/2"

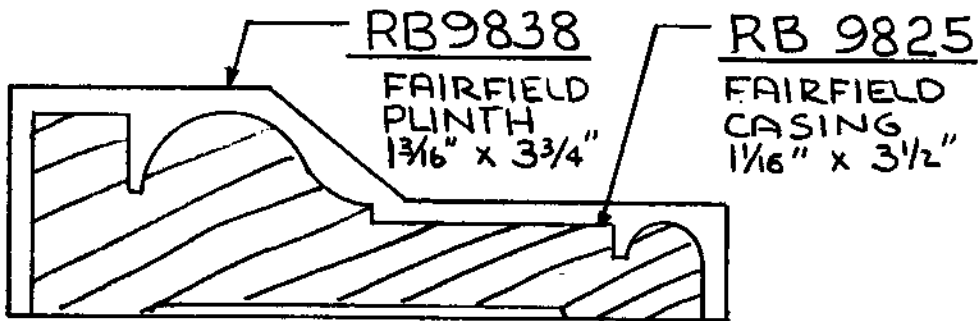

RB9838

FAIRFIELD  
PLINTH  
1 3/16" x 3 3/4"

RB 9825

FAIRFIELD  
CASING  
1 1/16" x 3 1/2"

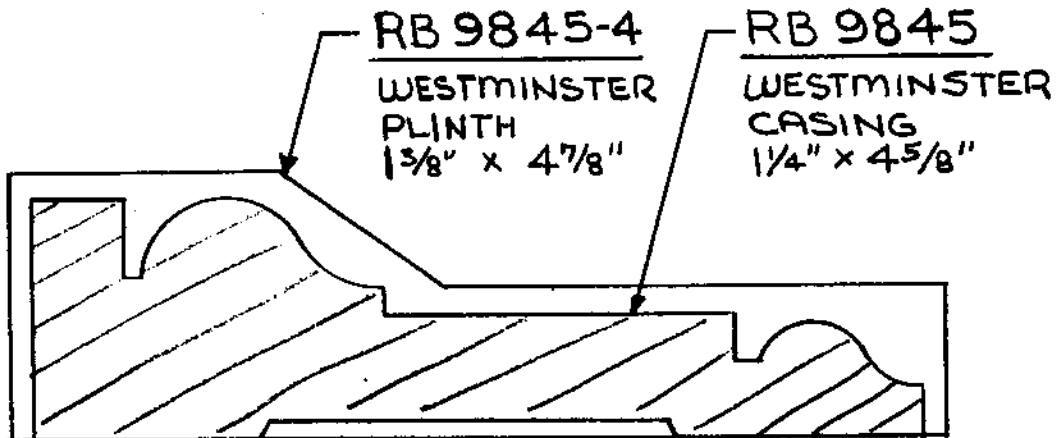

RB 9845-4

WESTMINSTER  
PLINTH  
1 3/8" x 4 7/8"

RB 9845

WESTMINSTER  
CASING  
1/4" x 4 5/8"

# RANDALL BROTHERS, INC.

665 MARIETTA STREET N.W.; ATLANTA, GA.

1-404  
PHONE 892-6666

1-404  
FAX. 875-6102

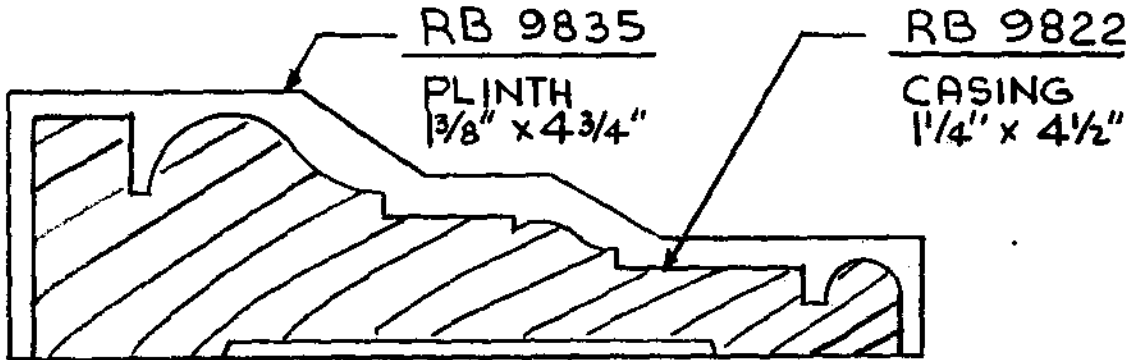

HABERSHAM ROAD CASING

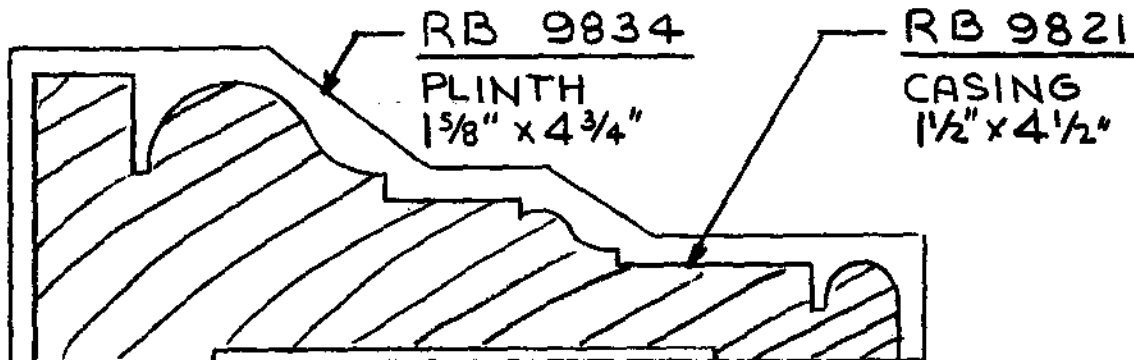

HABERSHAM PARK CASING

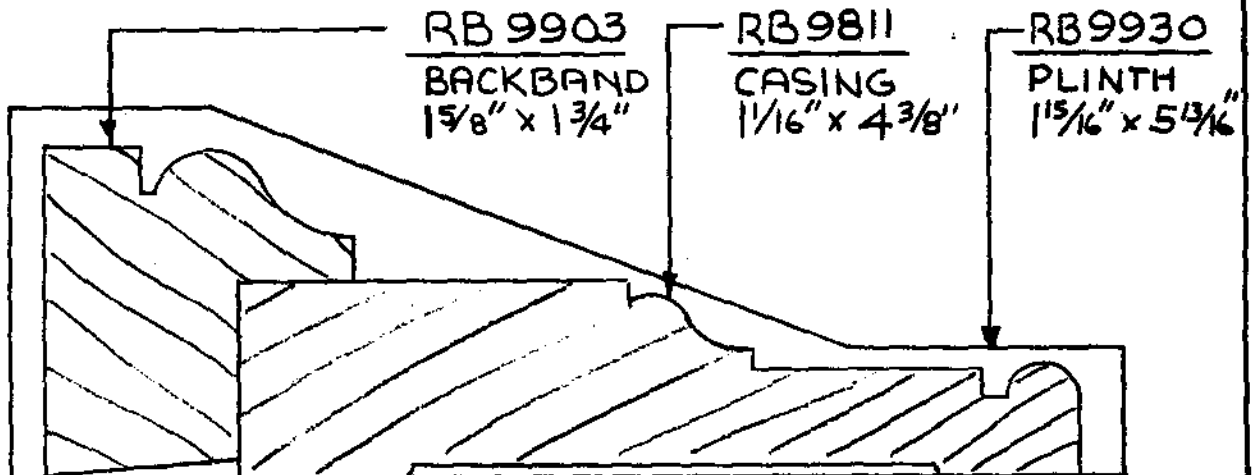

# RANDALL BROTHERS, INC.

665 MARIETTA STREET N.W.; ATLANTA, GA.

1-404  
PHONE 892-6666

1-404  
FAX. 875-6102

RB 9945  
CASING  
ROXBORO  
1 1/16" x 3 1/2"

RB 9946  
PLINTH  
ROXBORO  
1 1/4" x 3 3/4"

12

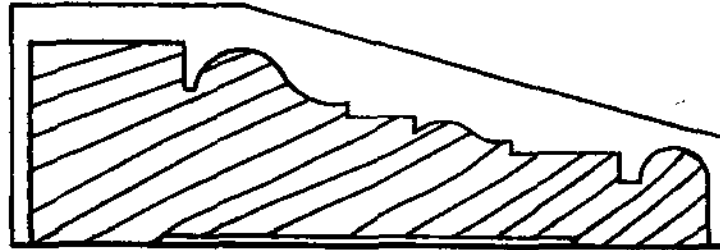

RB 9929  
PLINTH  
1 1/4" x 4 3/4"

RB 9904  
CASING  
1 1/16" x 4 1/2"

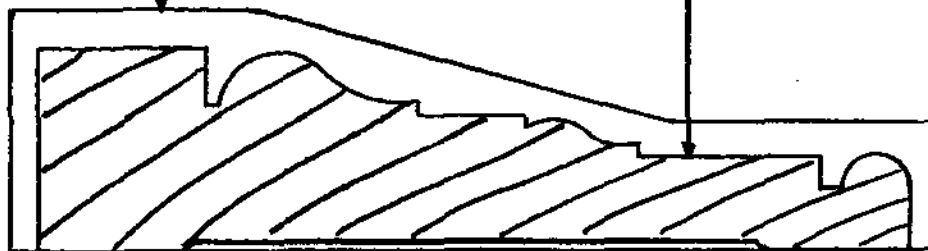

BROOKHAVEN CASING

RB 9903  
BACKBAND  
1 5/8" x 1 3/4"

RB 9904  
CASING  
1 1/16" x 4 1/2"

RB 9930  
PLINTH  
1 5/16" x 5 1/16"

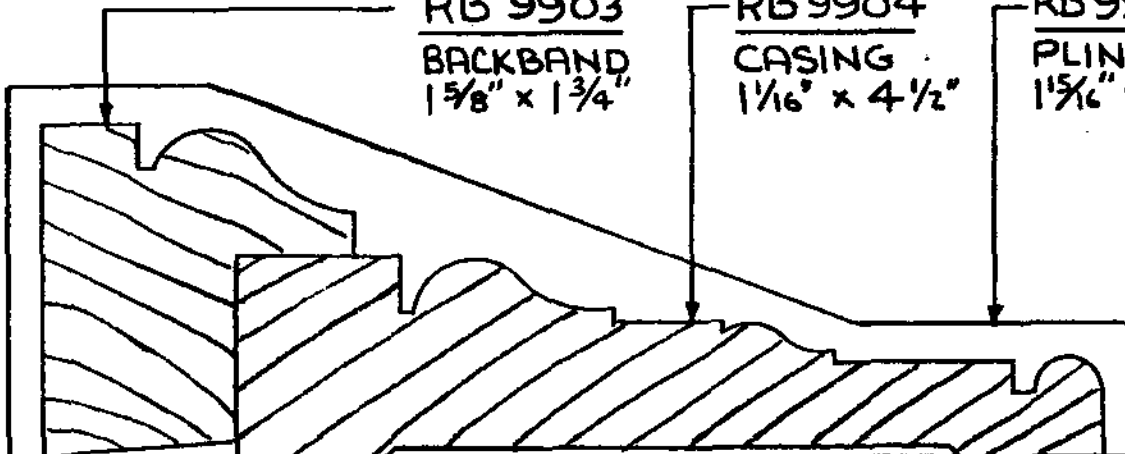

BROOKHAVEN CASING WITH BACKBAND

# RANDALL BROTHERS, INC.

665 MARIETTA STREET N.W., ATLANTA, GA.

1-404  
PHONE 892-6666

1-404  
FAX. 875-6102

13

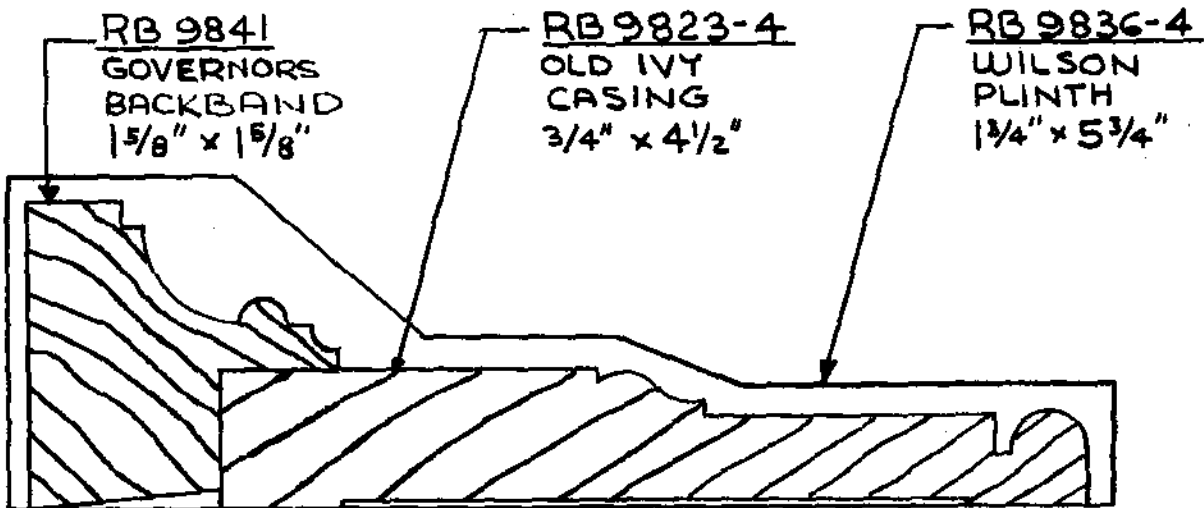
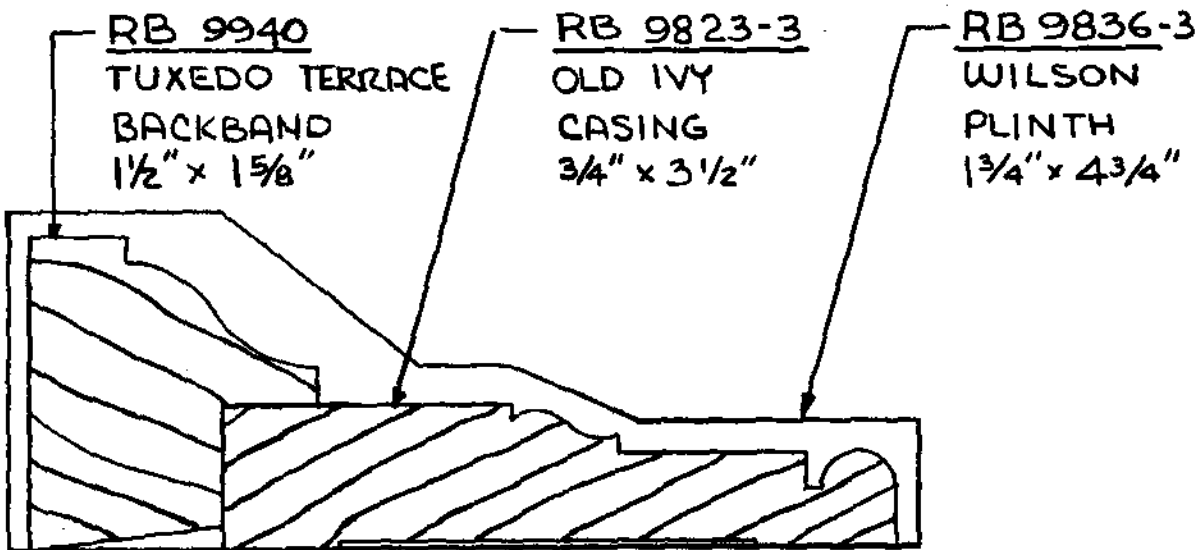
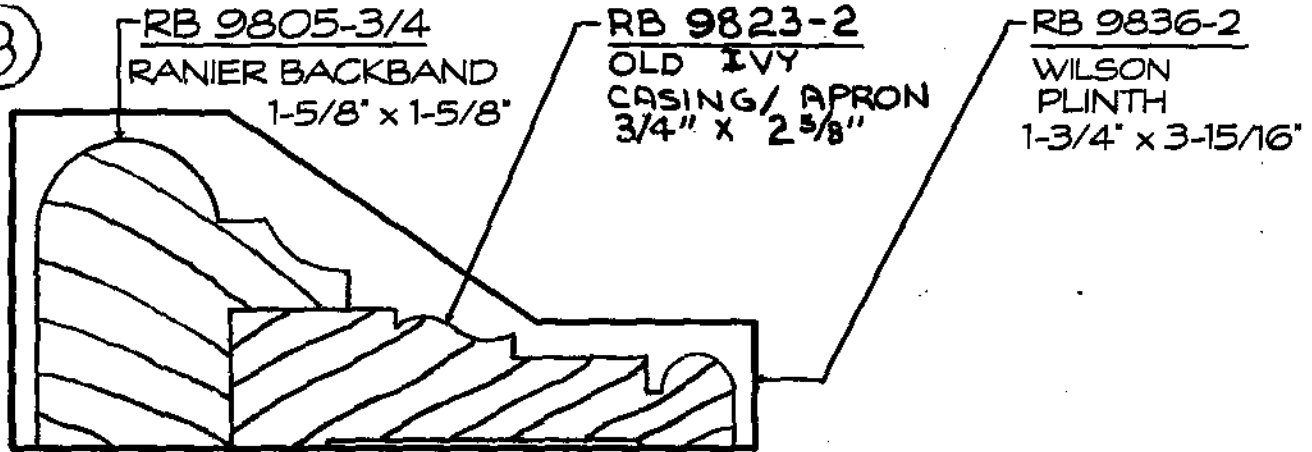

# RANDALL BROTHERS, INC.

865 MARIETTA STREET N.W.; ATLANTA, GA.

1-404  
PHONE 892-6666

1-404  
FAX. 875-6102

14

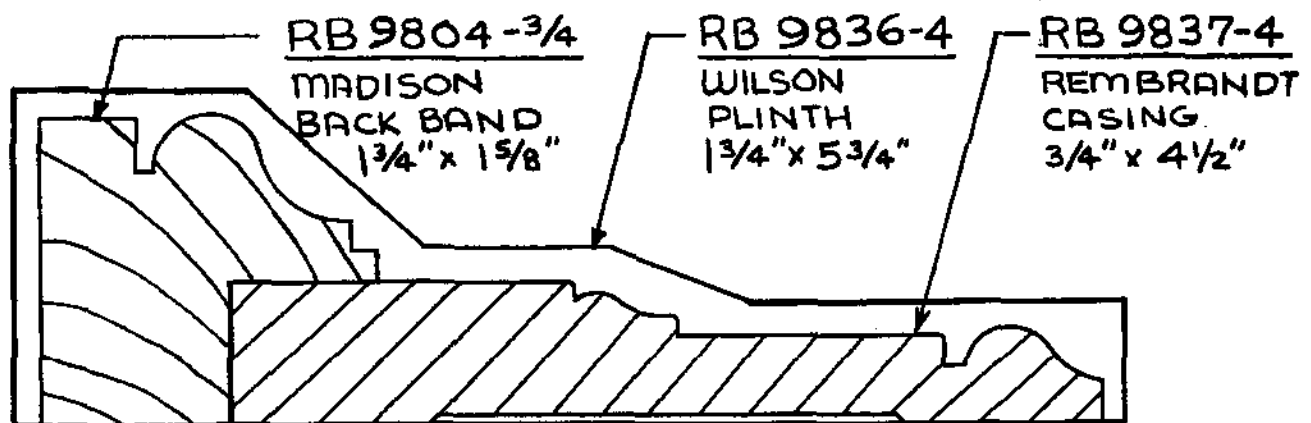
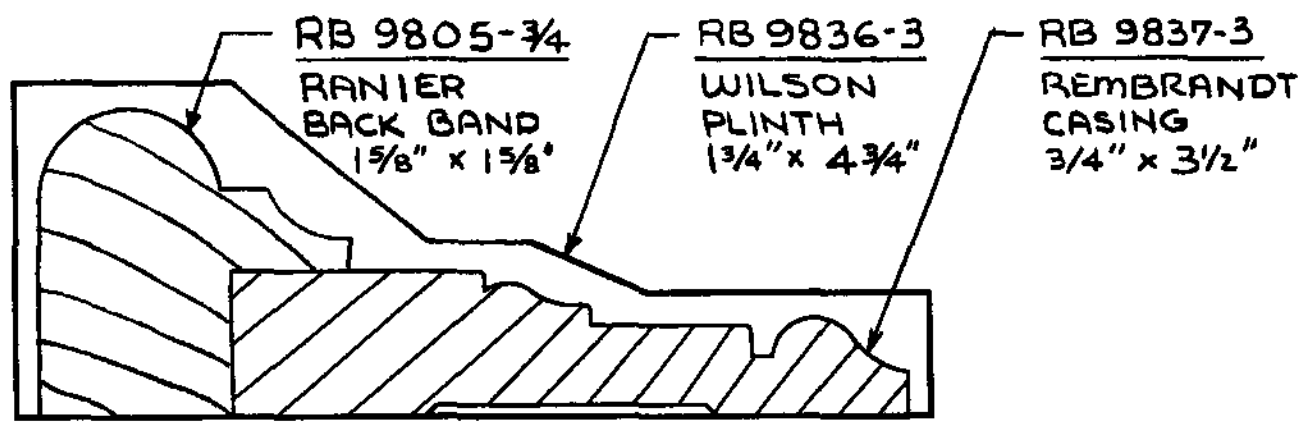
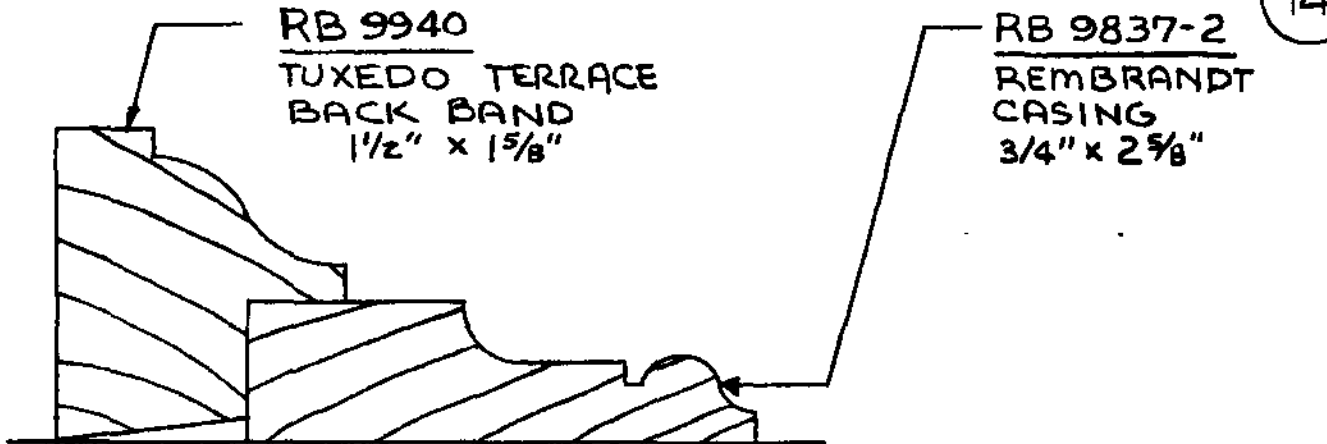

# RANDALL BROTHERS, INC.

865 MARIETTA STREET N.W.; ATLANTA, GA.

1-404  
PHONE 892-6866

1-404  
FAX. 875-6102

15

